

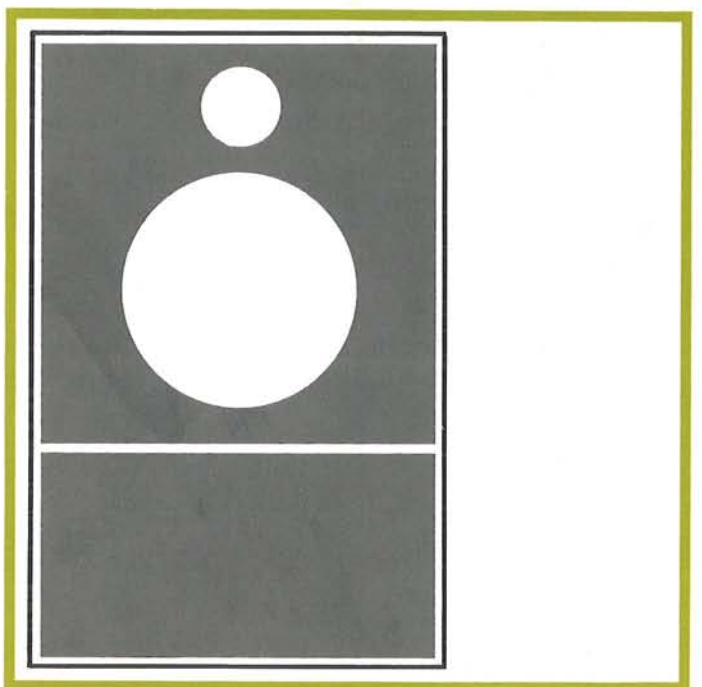

REFERENCE SERIES MODEL 103

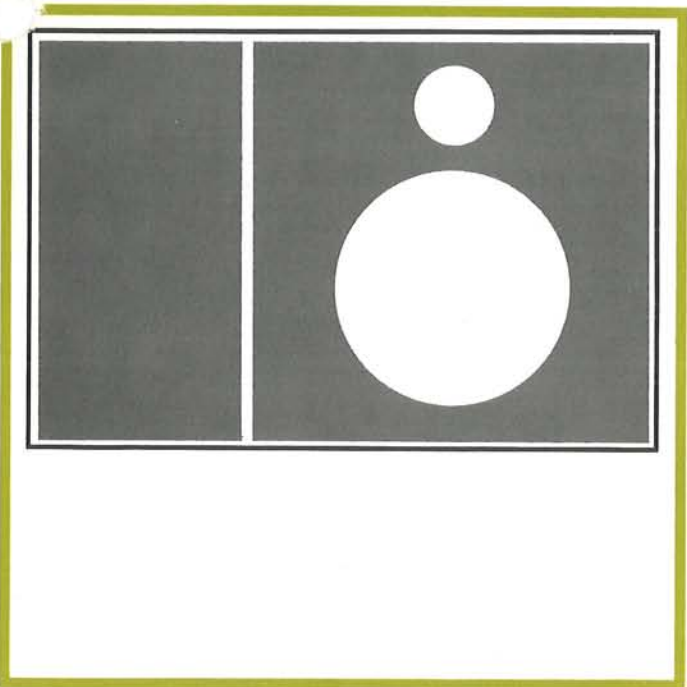
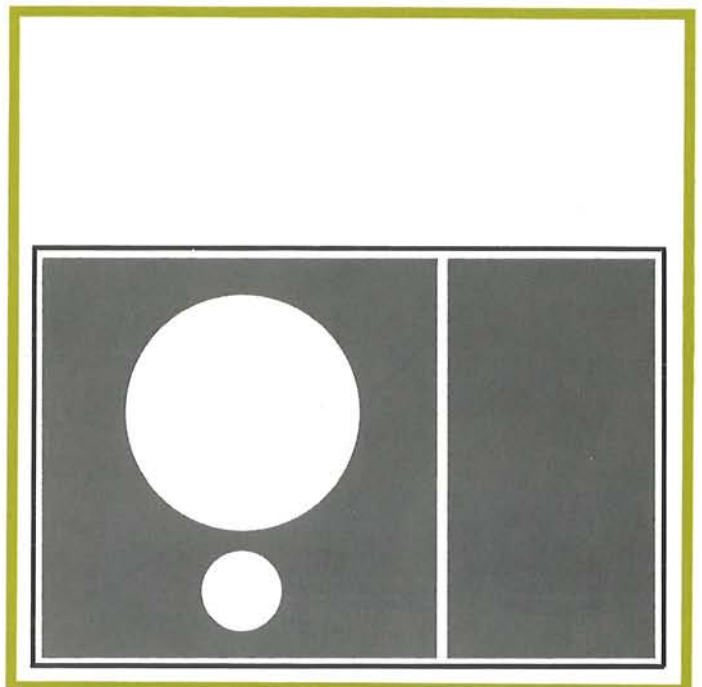
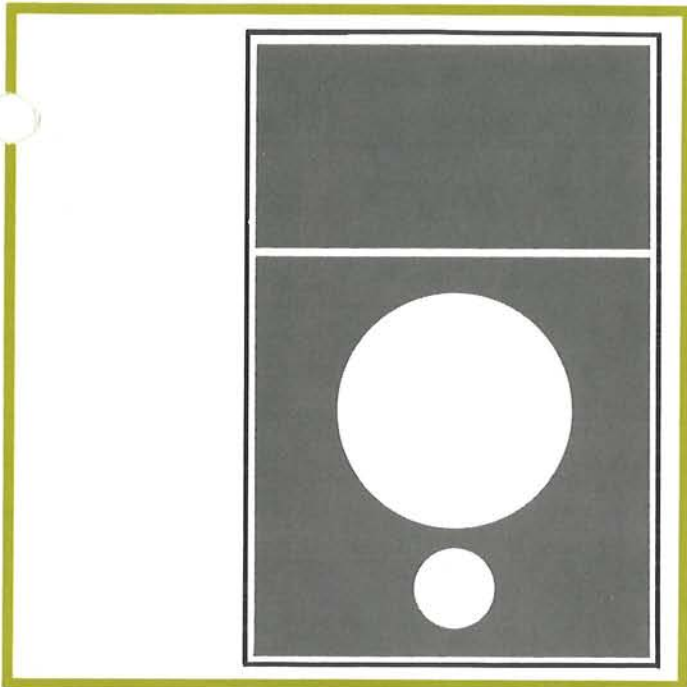

Colouration

The greatest enemy of natural sound reproduction is colouration. It alters the tonal character of instrumental sounds, upsets balance and distorts acoustic perspective.

Colouration is mainly caused by uncontrolled vibrations in the drive units and the cabinet enclosure. The radiating diaphragms in KEF loudspeakers are made from highly damped plastic materials pioneered by KEF in conjunction with renowned organisations such as the BBC. The diaphragm of the low frequency unit in Model 103 is made of a specially formulated rubber-modified polystyrene laminated to a visco-elastic damping layer with a high internal loss factor (Fig 1). This construction effectively dissipates unwanted stored energy in the diaphragm thus preventing diaphragm colouration.

Colouration due to cabinet wall vibration is reduced by internal bracing partitions and the use of laminated materials (Fig 2). Layered bituminous, anti-resonant linings effectively cancel any remaining resonances. (Fig 3).

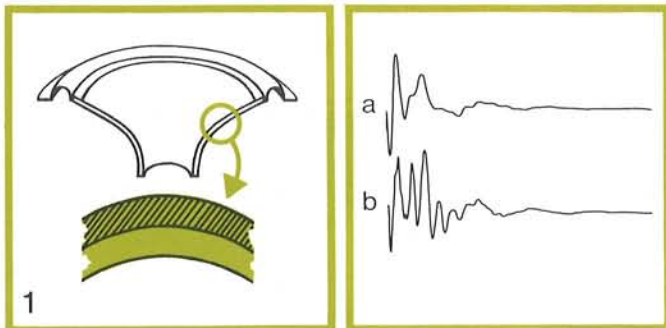

Impulse response showing diaphragm damped (a) and undamped (b).

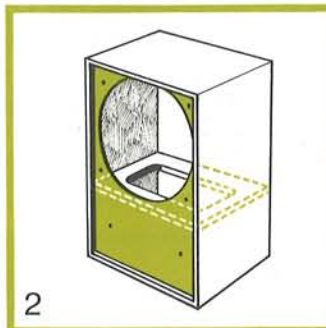

Impulse response showing cabinet damped (a) and undamped (b).

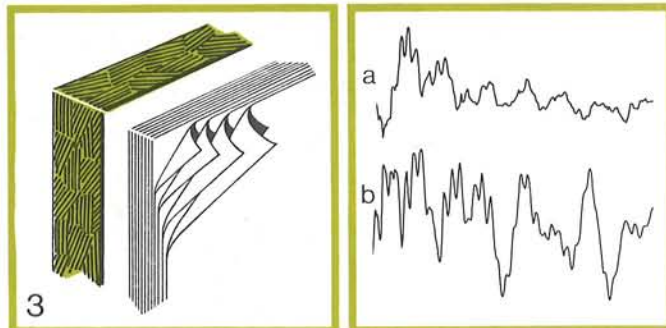

Power Handling Capability

Wide range loudspeakers of compact size are necessarily inefficient and high power amplifiers make great demands on power handling capabilities if realistic sound pressure levels are to be achieved. The special motor construction of the Model 103 low frequency unit is designed for low distortion and high heat dissipation (Fig 4). The anodised aluminium voice coil former (Fig 5) and special heat resistant epoxy resin allow the coil to operate safely at temperatures up to 350°C whilst the advanced design of the magnet assembly ensures perfect magnetic linearity.

Model 103 will handle the output from 100 watt amplifiers on musical programme.

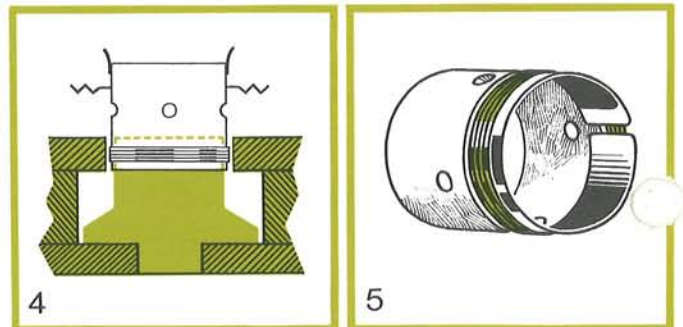

Drive Units and Dividing Network

High Frequency Radiator T52 Type SP1049. A new high frequency unit providing high power handling capabilities with exceptional transient response, wide dispersion and smooth frequency response (Fig 6).

Low Frequency Radiator B200 Type SP1039. This very special low/mid frequency unit is fitted with a coated Bextrene diaphragm and plasticised PVC cone suspension. The voice coil assembly will safely withstand short term overload to at least 350°C and continuous operation at 250°C (Fig 7).

Dividing Network DN16 Type SP1050. Capacitors selected to a 5% tolerance range and low hysteresis ferrite cored inductors ensure close adherence to design crossover frequencies and slopes. Total harmonic distortion due to filter network is less than 0.1% at 50 watts (20v RMS).

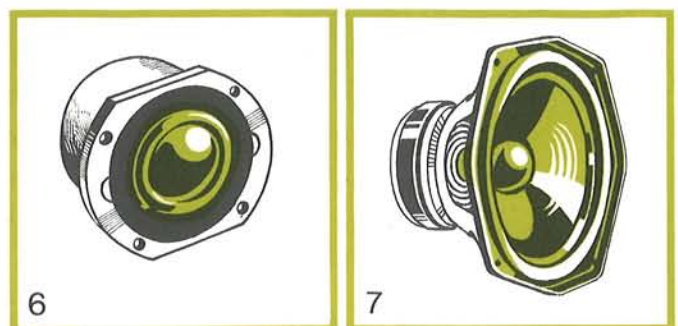

Environmental Adaptability

Model 103 provides broad, uniform sound dispersion for accurate stereo image formation. This is accomplished by centre-line mounting the low and high frequency unit very close together on a rigid steel panel with accurate matching of phase and amplitude between systems.

Accurate stereo image formation over the widest possible listening area also demands precise location of the loudspeaker systems. Multi-unit bookshelf systems can only provide maximum horizontal dispersion when used vertically or horizontally—but not both. When, for practical or visual considerations the systems cannot be used in the intended manner the acoustic performance will be degraded or compromises must be made.

Model 103 frees the user from these restrictions and enables positive stereo image formation whatever cabinet attitude is adopted. This is simply achieved by rotation of the steel speaker panel.

Fig 8 illustrates the manner in which bookshelf speakers are normally used, with the sharpest stereo image in the shaded area. If a more elevated position for either or both speakers is required the vertical sound dispersion will be impaired. Recognizing this fact KEF engineers developed the rotatable speaker panel which permits Model 103 to be used on any of its four sides even in elevated locations. Fig 9 clearly shows that the intended vertical and horizontal dispersion is preserved ensuring clear sharp stereo images over a wider area.

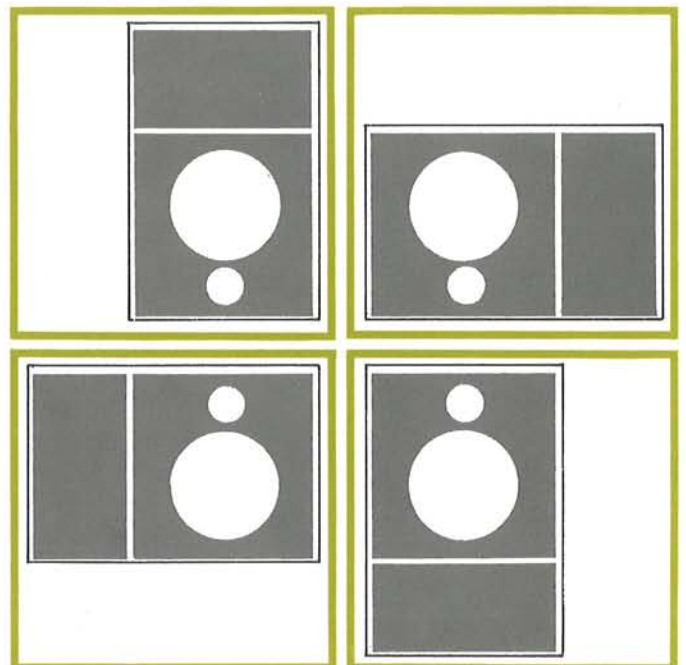
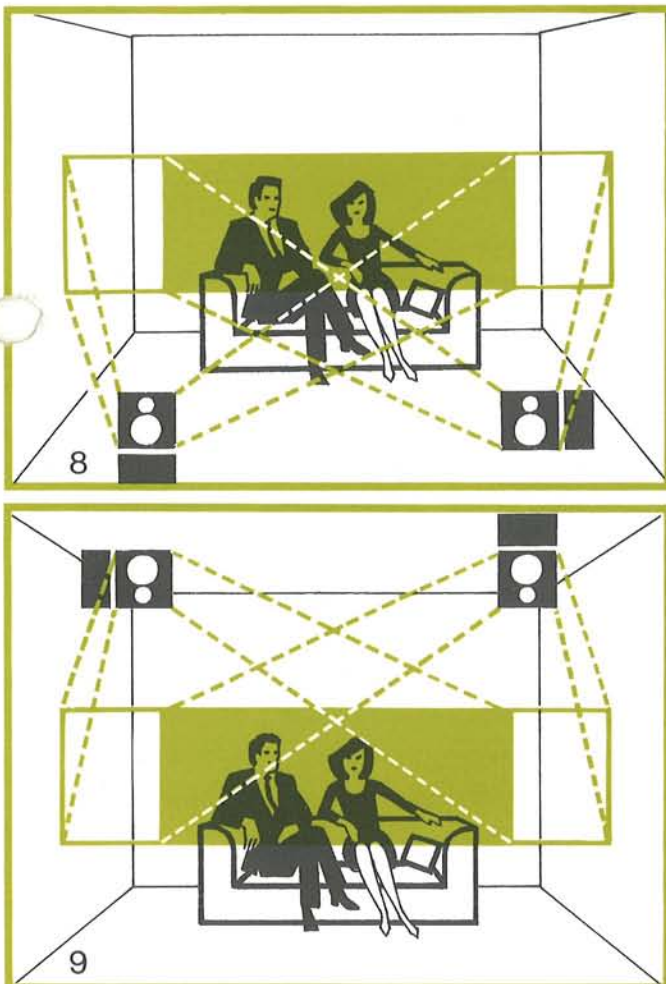

KEF Reference Series

KEF loudspeakers are designed to reproduce natural sound, free from exaggerated effects of balance and with the lowest possible distortion.

Research proves that natural sound is more accurately and consistently reproduced using synthetic materials in preference to traditional paper cones. This concept has been rigorously applied to all the Company's products for more than a decade and KEF is recognised throughout the world as a leading manufacturer of dependable, precision engineered loudspeakers.

In any question of sound quality, the ear must be the final judge. At KEF there is constant reference to live sound during the development of any product. KEF are assisted in this by major recording and broadcasting organisations, to whom they have supplied monitor loudspeakers for many years.

The terms Monitor and Professional are persistently misused to describe certain domestic loudspeakers, which are not subjected to the rigorous quality controls demanded by professional users.

With this in mind, a more factual description was sought to describe a new series of refined KEF loudspeaker systems. Their accuracy of reproduction with reference to live sound provided the obvious name—The KEF Reference Series.



KEF REFERENCE SERIES
MODEL 103

Model 103 is a new bookshelf type loudspeaker of the highest quality with generous power handling ability. Novel features give it clear advantages over other bookshelf systems.

- * Model 103 minimises colouration and non-linear distortion providing smooth, transparent reproduction.
- * High sound pressure levels are possible without becoming hard and opaque.
- * The unique design affords a flexibility of installation not previously attainable with bookshelf type loudspeakers.

Model 103 joins the larger, internationally acclaimed Model 104 in this exciting new series of loudspeakers.

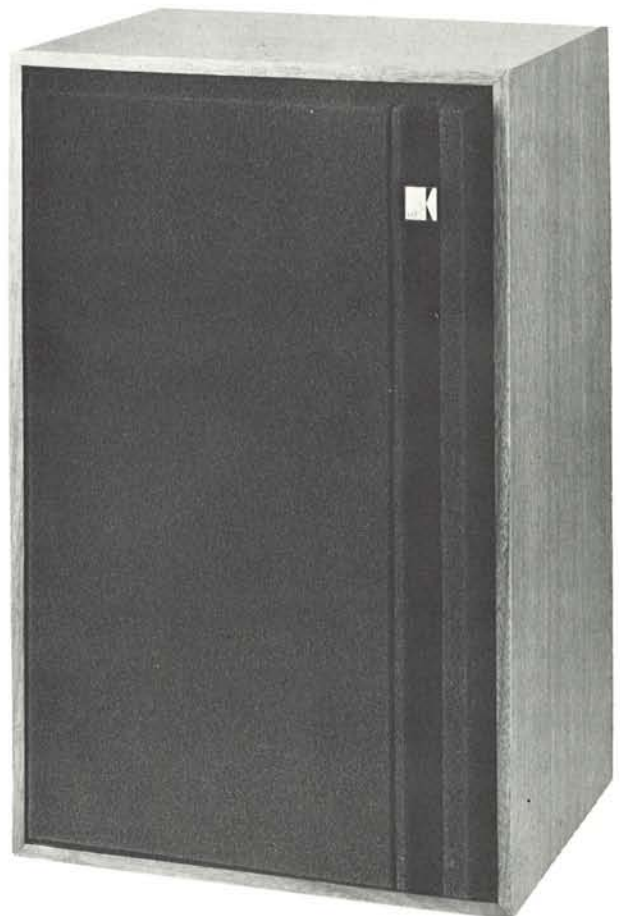

Model 103

Horizontal Dispersion

Microphone 1 metre on HF unit axis

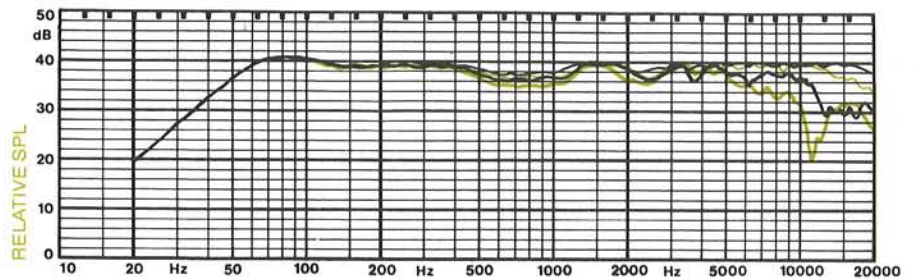
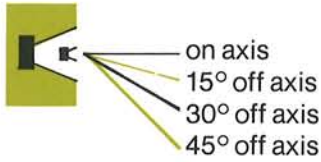

Model 103

Vertical Dispersion

Microphone 1 metre on HF unit axis

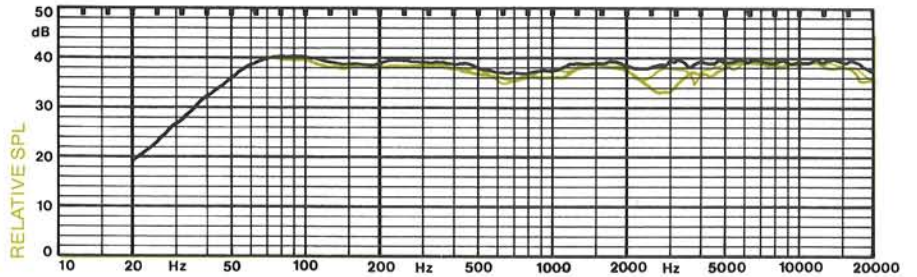
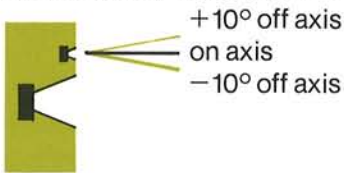

Model 103

Impedance v Frequency

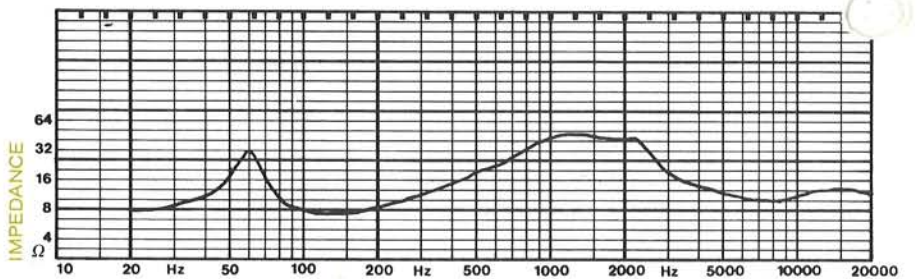

Model 103

Harmonic Distortion

Microphone 1 metre on HF unit axis -
Input 8v

- fundamental
- 2nd harmonic
- 3rd harmonic

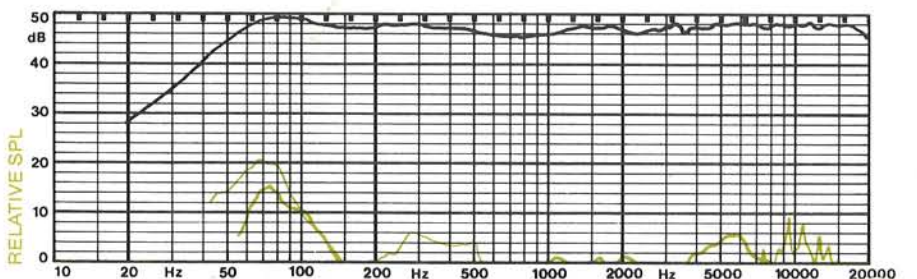

Specification

Dimensions: 500 × 330 × 225 mm
19.7 × 13 × 8.9 in

Internal Volume: 25.4 litres

Weight (Net): 19.05 kg/41.88 lb

Nominal Impedance: 8 ohms

Power Ratings:

- a) Maximum Rated Power - 100 watts programme
- b) Continuous Sine Wave Rating - 25v (80w)
100-2500 Hz reducing to:
10v (12w) above 3000 Hz

Frequency Response:

- a) Nominal Frequency Range - 30-20,000 Hz
- b) Specific Frequency Response - ±2dB
50-20,000 Hz

System Resonance: 58 Hz

Dividing Frequency: 3000 Hz (electrical cut-off
slope 18dB/8ve)

Harmonic Distortion: 1% THD 100-20,000 Hz
relative to 96dB SPL @ 400 Hz
3% THD @ 50 Hz

Sensitivity: 25 watts into nominal 8 ohms produces
96dB at one metre and 400 Hz in anechoic
conditions

Amplifier Requirements: 25-100 watts into 8 ohms

Room Size: Up to 280 cubic metres (10,000 cu ft)

Finishes: Walnut, Teak

Grille: Black Microcellular Foam



KEF Electronics Limited Tovil Maidstone ME15 6QP Kent ☎ 0622 57258

Registered in England No 702392

KEF reserve the right to incorporate developments and amend the specifications without prior notice, in line with continuous research and product improvement.

Printed in England 11/75/103-1